

## Internal Gear Unit

for motor/pump function  
Series QXM

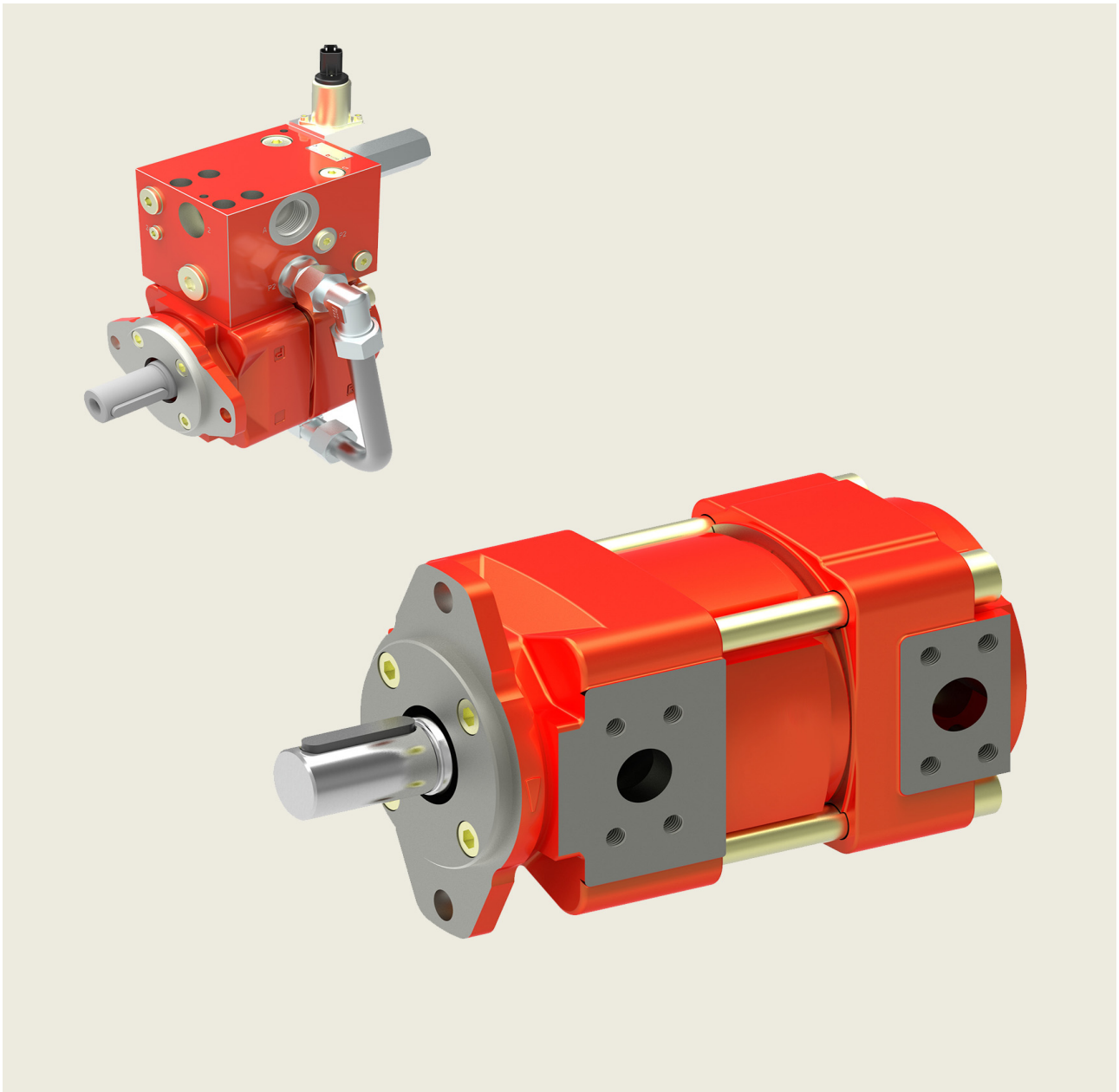



<b>Contents</b>		<b>Page</b>
<b>1</b>	<b>General</b> .....	<b>5</b>
1.1	Product description .....	5
1.2	Advantages .....	5
1.3	Application .....	5
1.4	ATEX compliant explosion protection .....	5
<b>2</b>	<b>Technical data</b> .....	<b>5</b>
2.1	General .....	5
2.2	Main characteristics for pressure range 1 .....	6
2.3	Main characteristics for pressure range 2 .....	7
2.4	Main characteristics for pressure range 3 .....	7
<b>3</b>	<b>Performance graphs</b> .....	<b>8</b>
3.1	Pressure range 1 .....	8
3.2	Pressure range 2 .....	9
3.3	Pressure range 3 .....	10
3.4	Noise level (Lp) .....	11
<b>4</b>	<b>Dimensions</b> .....	<b>11</b>
4.1	Pressure range 1 .....	12
4.2	Pressure range 2 .....	12
4.3	Pressure range 3 .....	13
4.4	Ordering details .....	13
4.5	Ordering example .....	13
4.6	Standard configuration .....	13
4.7	Special features .....	14
4.8	Direction of rotation .....	14
<b>5</b>	<b>Fluid cleanliness</b> .....	<b>14</b>
<b>6</b>	<b>Note</b> .....	<b>14</b>
<b>7</b>	<b>Fluid cleanliness</b> .....	<b>14</b>
<b>8</b>	<b>Operational reliability</b> .....	<b>14</b>
<b>9</b>	<b>Accessories</b> .....	<b>15</b>
9.1	Pipe flanges - high pressure type .....	15
9.2	Low pressure type .....	15
9.3	Bolt-on valves - SAE J518 code 61 / ISO 6162-1 pattern .....	16



## 1 General

### 1.1 Product description

The QXM internal gear unit can be used in open- and closed-loop hydrostatic drives, and can operate both as a pump and as a motor.

This flexibility offers possibilities for various applications, one example being the raising and lowering of loads. The QXM works as a pump to lift the load and recovers energy when the load is being lowered.

Used as a fully bi-directional pump/motor (four-quadrant operation), the unit controls a complete motion cycle of a cylinder. Fast acceleration/deceleration sequences can be achieved.

The unit is based on the well-known QX internal gear pump, which is distinguished by its very low noise levels and almost imperceptible pressure pulsations. The large number of closely spaced sizes ensures that the right size is always available for every application.

### 1.2 Advantages

- very low noise levels
- negligible pressure pulsations
- 400 bar maximum pressure
- long service life
- suitable for special fluids such as HFB, HFC, HFD and bio-degradables
- suitable for variable-speed operation
- 2- and 4-quadrant operation is possible
- optimised flow path cross-sections and special gear profile give low susceptibility to cavitation

### 1.3 Application

- Injection molding machines
- Hydraulic presses
- Flight simulators
- Wind-power plants
- Lift/elevator drives
- Winches

### 1.4 ATEX compliant explosion protection

The internal gear unit QXM is suitable for application in hazardous areas and complies with the following guidelines:

ATEX directive 2014/34/EU  
group II  
equipment category 3  
atmosphere G  
temperature class T3 and T4



II 3 G EEx c II T4  
-20°C ≤ Ta ≤ +40°C



II 3 G EEx c II T3  
-20°C ≤ Ta ≤ +80°C

## 2 Technical data

### 2.1 General

Characteristics	Unit	Description, value
Installation attitude		unrestricted
Mounting method (standard)		oval 2-hole flange to ISO 3019/1 (SAE): QXM 3-6 oval 2-hole flange to ISO 3019/2 (metric) QXM 2+8
Direction of rotation		unrestricted
Drive method		in-line, by a flexible coupling
Hydraulic fluid		HLP mineral oils to DIN 51524, Part 2 HFB, HFD and HFC fluids to VDMA 24317 other fluids - contact Bucher Hydraulics

Characteristics	Unit	Description, value
Max. admissible level of contamination of the hydraulic fluid		ISO 4406 class 20/18/15
Operating viscosity Starting viscosity	mm <sup>2</sup> /s	10 ... 100 10 ... 300 (higher values, contact Bucher Hydraulics)
Hydraulic fluid temperature	°C	HLP mineral oil 80 max. HFB, HFD and HFC 50 max.
Max. pressure at drain port	bar	1.5 absolute (higher values, contact Bucher Hydraulics)
Accumulated pressure restriction		Port P <sub>1</sub> + Port P <sub>2</sub> ≤ continuous-/intermittent pressure

**IMPORTANT:** The main characteristics are valid for hydraulic oils DIN 51524 with a viscosity of 42mm<sup>2</sup>/s.

## 2.2 Main characteristics for pressure range 1

Type	Displacement		minimum Motor Speed [min <sup>-1</sup> ] <sup>5)</sup>		maximum Speed [min <sup>-1</sup> ] <sup>3)</sup>		Operating pressure [bar]		Torque <sup>2)</sup> [Nm]
	nominal [cm <sup>3</sup> /U]	effective [cm <sup>3</sup> /U]	Operating pressure on inlet side ... 50%   ... 100%		Pump operat. <sup>4)</sup>	Motor operating	conti- nous	intermit- tent <sup>1)</sup>	
QXM21-010 QXM21-012 QXM21-016	010 012 016	10 12,6 15,6	1000	2500	4000 3600 3200	5500	160 125 100	210 160 125	25
QXM31-020 QXM31-025 QXM31-032	020 025 032	20,3 25,1 32,3	800	2000	3200 3000 2700	5000	160 125 100	210 160 125	50
QXM41-040 QXM41-050 QXM41-063	040 050 063	39,2 50,5 63,5	600	1500	2700 2350 2050	4600	160 125 100	210 160 125	100
QXM51-080 QXM51-100 QXM51-125	080 100 125	80,1 100,9 124,6	600	1500	2050 1900 1620	4000	160 125 100	210 160 125	200
QXM61-160 QXM61-200 QXM61-250	160 200 250	162,7 200,9 248,8	600	1500	1500 1350 1200	3200	160 125 100	210 160 125	400
QXM81-315 QXM81-400 QXM81-500	315 400 500	326 402,6 498,5	600	1200	1200 1100 1000	3000	160 125 100	210 160 125	800

1) Intermittent pressure for max. 20 sec/min but not more than 10% of the duty cycle.

2) Theoretical value at the maximum permitted continuous pressure. For starting torques, see section 3.

3) For higher speed contact us.

4) Minimum inlet pressure 1 bar absolute.

5) Recommended speed. For less speed the pressure must be reducing (linear rate). For customized working cycle contact Bucher Hydraulics.

## 2.3 Main characteristics for pressure range 2

Type	Displacement		minimum Motor Speed [min <sup>-1</sup> ] <sup>5)</sup>		maximum Speed [min <sup>-1</sup> ] <sup>3)</sup>		Operating pressure [bar]		Torque <sup>2)</sup> [Nm]
	nominal [cm <sup>3</sup> /U]	effective [cm <sup>3</sup> /U]	Operating pressure on inlet side ... 50%   ... 100%		Pump operat. <sup>4)</sup>	Motor operating	conti- nous	intermit- tend <sup>1)</sup>	
QXM22-005	005	5,1	1650	3000	3250	6000	210	250	17
QXM22-006	006	6,3							
QXM22-008	008	8,0							
QXM32-010	010	10,0	1400	2500	3050	5500	210	250	33,5
QXM32-012	012	12,6							
QXM32-016	016	15,6							
QXM42-020	020	20,3	1000	1800	2900	5000	210	250	68
QXM42-025	025	25,1							
QXM42-032	032	32,3							
QXM52-040	040	39,2	1000	1800	2500	4500	210	250	131
QXM52-050	050	50,5							
QXM52-063	063	63,5							
QXM62-080	080	80,1	1000	1800	2250	4000	210	250	268
QXM62-100	100	100,9							
QXM62-125	125	124,6							
QXM82-160	160	162,7	1000	1800	1600	3500	210	250	544
QXM82-200	200	200,9							
QXM82-250	250	248,8							

## 2.4 Main characteristics for pressure range 3

Type	Displacement		minimum Motor Speed [min <sup>-1</sup> ] <sup>5)</sup>		maximum Speed [min <sup>-1</sup> ] <sup>3)</sup>		Operating pressure [bar]		Torque <sup>2)</sup> [Nm]
	nominal [cm <sup>3</sup> /U]	effective [cm <sup>3</sup> /U]	Operating pressure on inlet side ... 50%   ... 100%		Pump operat. <sup>4)</sup>	Motor operating	conti- nous	intermit- tend <sup>1)</sup>	
QXM23-005	005	5,1	1200	2500	3250	6000	320	400	26
QXM23-006	006	6,3							
QXM23-008	008	8,0							
QXM33-010	010	10,0	1000	2000	3050	5500	320	400	51
QXM33-012	012	12,6							
QXM33-016	016	15,6							
QXM43-020	020	20,3	750	1500	2900	5000	320	400	103
QXM43-025	025	25,1							
QXM43-032	032	32,3							
QXM53-040	040	39,2	750	1500	2500	4500	320	400	200
QXM53-050	050	50,5							
QXM53-063	063	63,5							
QXM63-080	080	80,1	750	1500	2250	4000	320	400	408
QXM63-100	100	100,9							
QXM63-125	125	124,6							
QXM83-160	160	162,7	750	1500	1600	3500	320	400	828
QXM83-200	200	200,9							
QXM83-250	250	248,8							

1) Intermittent pressure for max. 20 sec/min but not more than 10% of the duty cycle.

2) Theoretical value at the maximum permitted continuous pressure. For starting torques, see section 3.

3) For higher speed contact us.

4) Minimum inlet pressure 1 bar absolute.

5) Recommended speed. For less speed the pressure must be reducing (linear rate). For customized working cycle contact Bucher Hydraulics.

## 3 Performance graphs

### 3.1 Pressure range 1

#### 3.1.1 Volumetric efficiency

Measured with  $n = 1450 \text{ min}^{-1}$ , viscosity  $42 \text{ mm}^2/\text{s}$ .

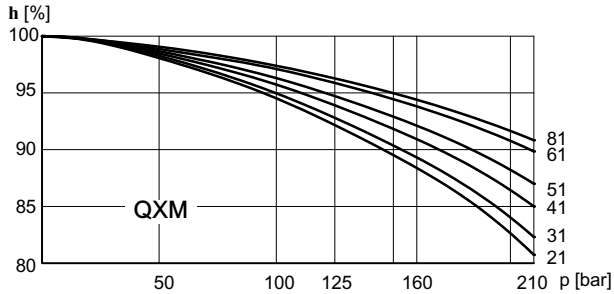

#### 3.1.2 Hydro-mechanical efficiency

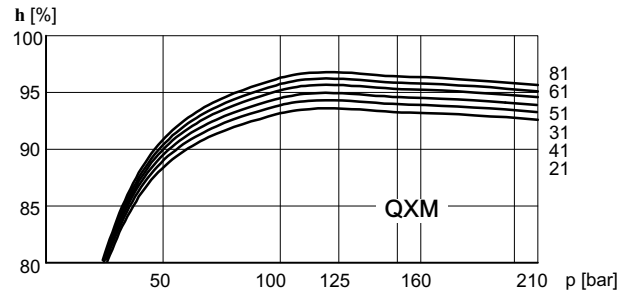

#### 3.1.3 Starting torque

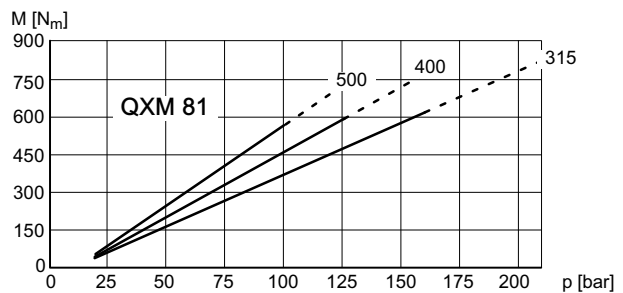
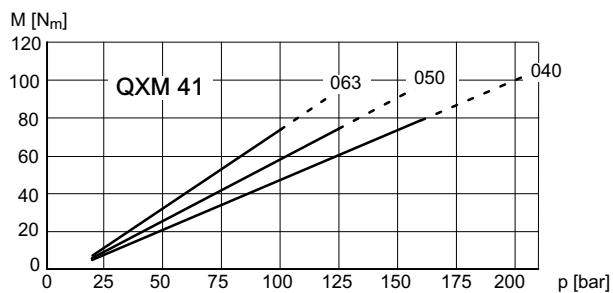
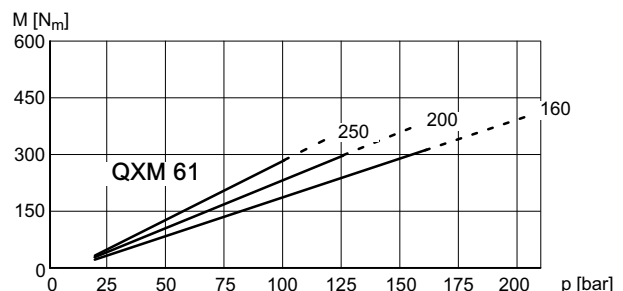
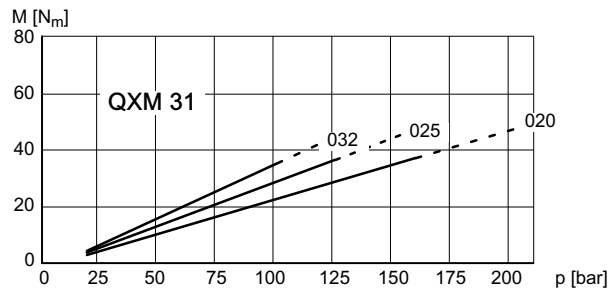
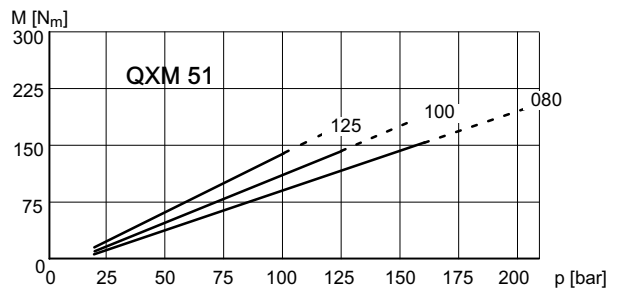
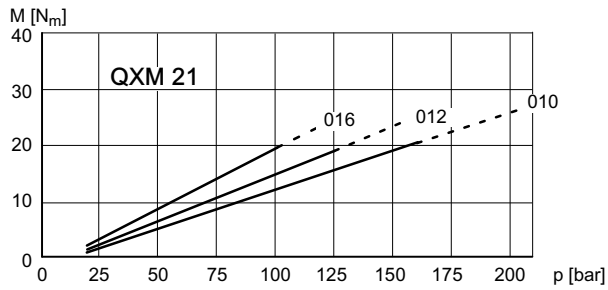

#### 3.1.4 Maximum pressure accumulation at $P_1 + P_2$

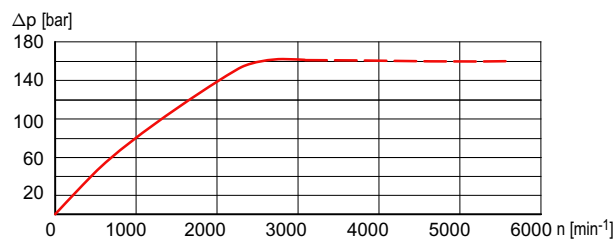

--- = Dependent on frame size (see 2.2)



## 3.2 Pressure range 2

### 3.2.1 Volumetric efficiency

Measured with viscosity 42 mm<sup>2</sup>/s, speed 1450 min<sup>-1</sup>

Solid line = continuous pressure / dashed line = max. intermittent pressure

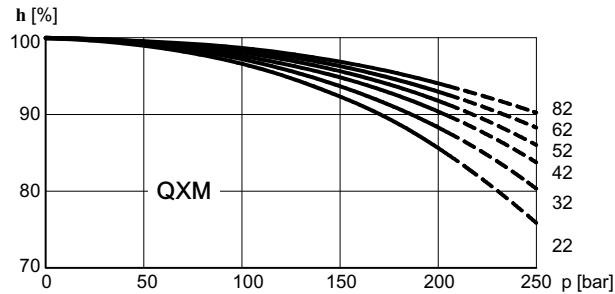

### 3.2.2 Hydro-mechanical efficiency

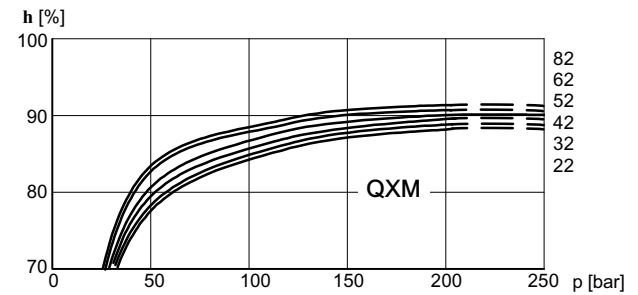

### 3.2.3 Starting torque

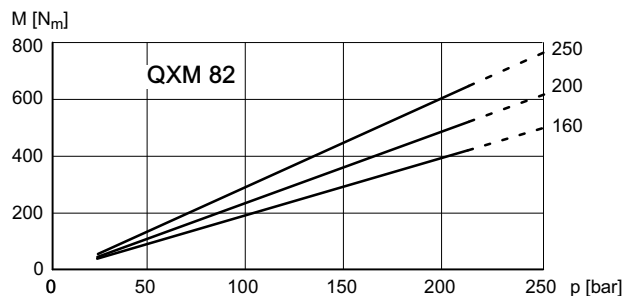
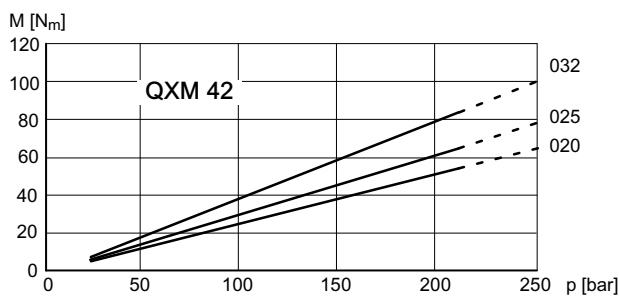
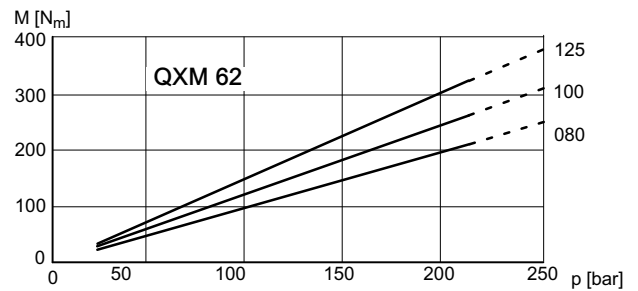
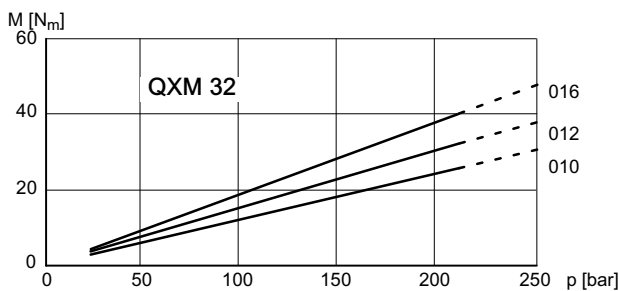
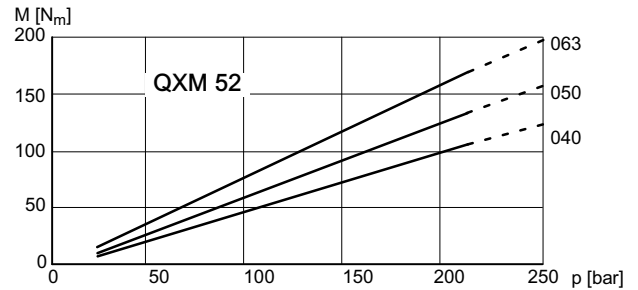
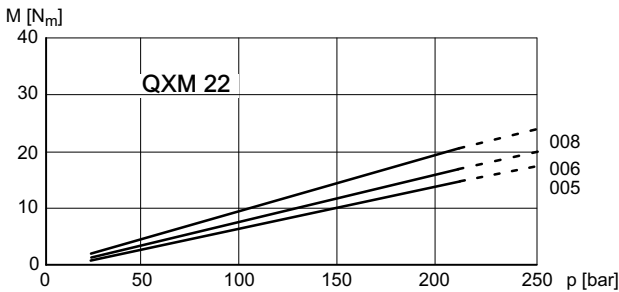

### 3.2.4 Maximum pressure accumulation at P<sub>1</sub> + P<sub>2</sub>

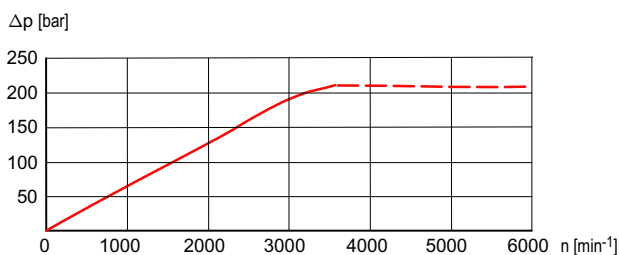

----- = Dependent on frame size (see 2.3)

## 3.3 Pressure range 3

### 3.3.1 Volumetric efficiency

Measured with viscosity 42 mm<sup>2</sup>/s, speed 1450 min<sup>-1</sup>,  
 Solid line = continuous pressure / dashed line = max. intermittent pressure

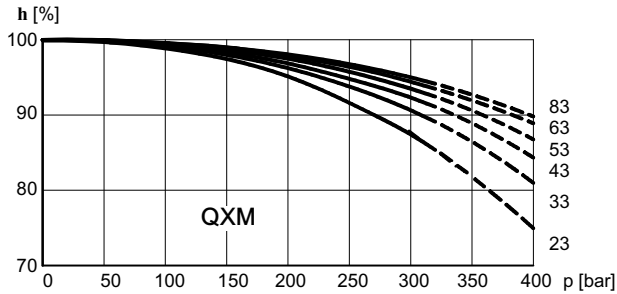

### 3.3.2 Hydro-mechanical efficiency

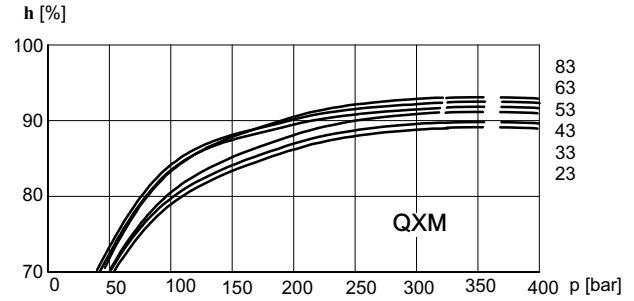

### 3.3.3 Starting torque

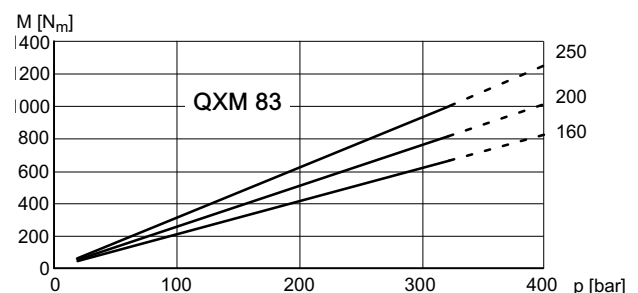
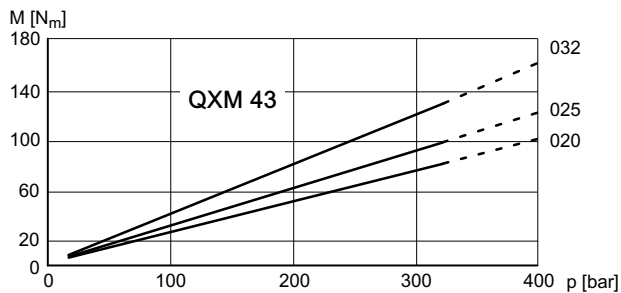
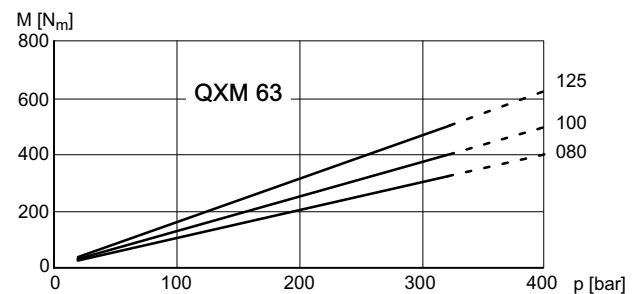
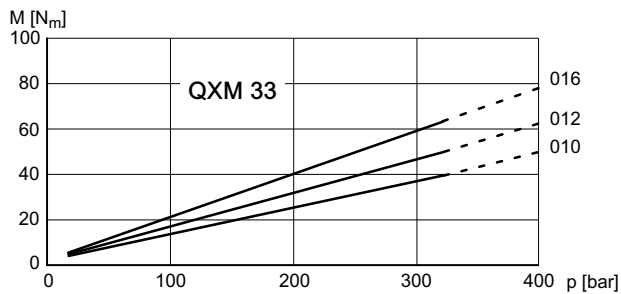
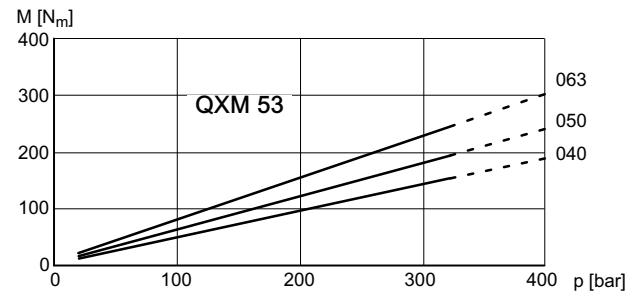
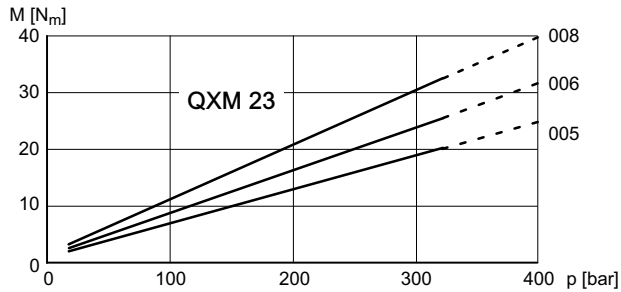

### 3.3.4 Maximum pressure accumulation at $P_1 + P_2$

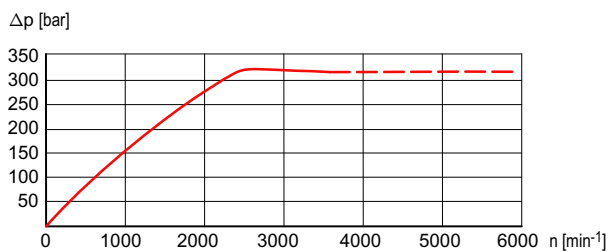

----- = Dependent on frame size (see 2.4)

### 3.4 Noise level ( $L_p$ )

Measured to DIN 45635, Part 26, in low-echo noise measurement chamber;  
measurement distance 1 m; speed  $n = 1500$  rpm; viscosity = 42 mm<sup>2</sup>/s

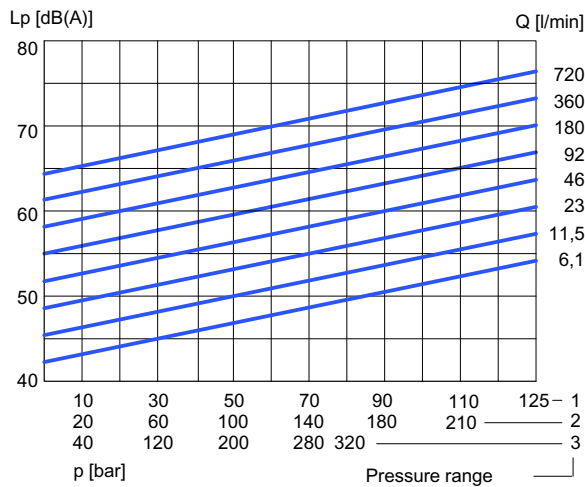

## 4 Dimensions

Frame size	2			3			4			5			6			8													
	1	2	3	1	2	3	1	2	3	1	2	3	1	2	3	1	2	3											
Service ports to SAE J518 <sup>1)</sup>	P <sub>1</sub> , P <sub>2</sub>		G1/2" <sup>3)</sup> thread			G 3/4" <sup>3)</sup> thread			1"			1 1/4"			1 1/2"			2"											
Drain port to DIN 3852 Teil 2 Part 2	P <sub>L</sub>		G1/4"			G1/4"			G1/4"			G1/4"			G 3/8"			G1/2"											
Mounting: oval 2-hole flange to ISO 3019/1 (SAE - size 3-6) ISO 3019/2 (Metr. - sizes 2+8)	A		118			132			170			212			267			330											
	B <sub>(SAE)</sub>		-			106			146			181			229			-											
	B <sub>(Metr.)</sub>		100			109			140			180			224			280											
	C		9			11			14			18			22			26											
	N <sub>(SAE)</sub>		-			82,55 - 0,05			101,6 - 0,05			127 - 0,05			152,4 - 0,05			-											
	N <sub>(Metr.)</sub>		63 h8			80 h8			100 - h8			125 h8			160 h8			200 h8											
	O		8,5			8,5			10,5			12,5			16,5			20											
V		6			6			7			7			7			9												
Shaft end: parallel, to ISO/R775 <sup>2)</sup>	D		20 j6			25 j6			32 j6			40 j6			50 j6			63 j6											
	E		36			42			58			82			82			105											
	F		6			8			10			12			14			18											
	G		22,5			28			35			43			53,5			67											
	I		45			50			68			92			92			117											
Housing	K		37,5			44			52,5			60,5			74			90											
	L		139,5	121,5	156,5	165,5	145,5	190,5	203,5	178	233,5	243,5	211,5	281,5	288	249	339	361	331	429									
	M		-	55	90	-	69,5	114,5	-	87	143	-	102	172	-	119	209	-	151	266									
	T1		43			53,5			66,5			67			66,5			88,5			107			110			137,5		
	T2		43			53,5			66,5			70			66,5			88,5			107			110			137,5		
	Z		100			120			125			156			195			250											
	W		80			100			123			165			203			264											
Weight	kg	5,7	5,4	6,5	10,3	9,2	12,4	19	17	20	34	31	41	59	56	76	129	122	155										

1) For SAE J518 code 61 bzw. ISO6162-1 pipe flange dimensions see section 9.

2) For other shaft ends, contact Bucher Hydraulics.

3) Threaded ports to DIN 3852 Part 2.

4.1 Pressure range 1

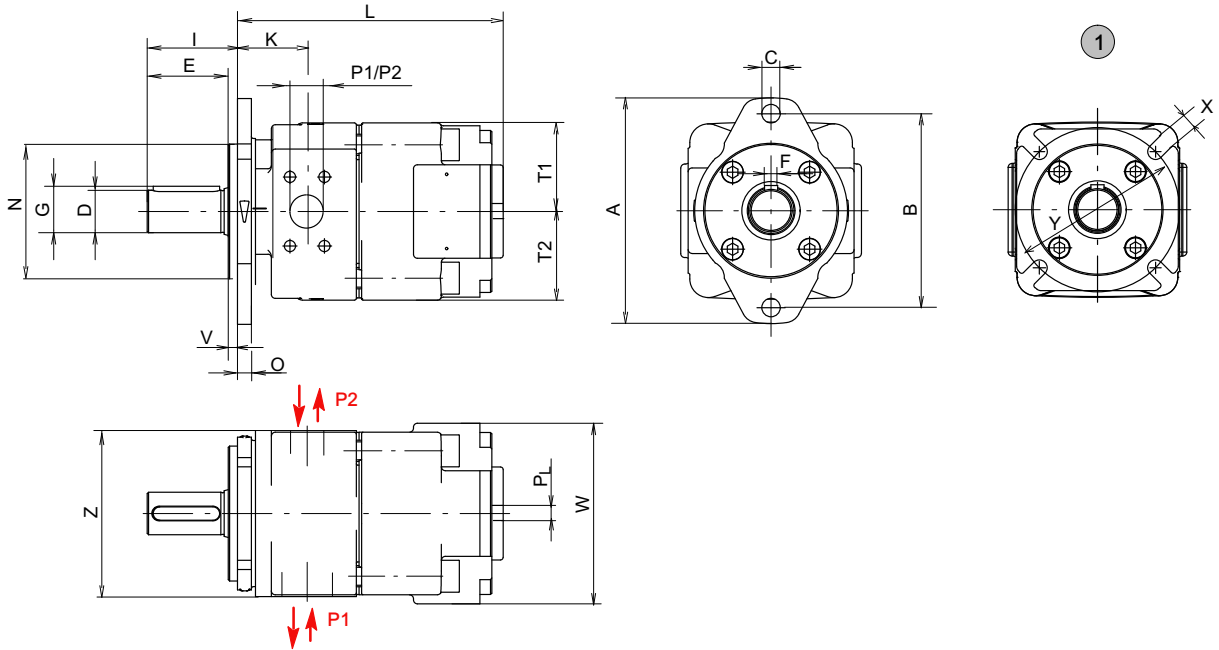

1 special model: 4-hole flange ISO 3019/2

4.2 Pressure range 2

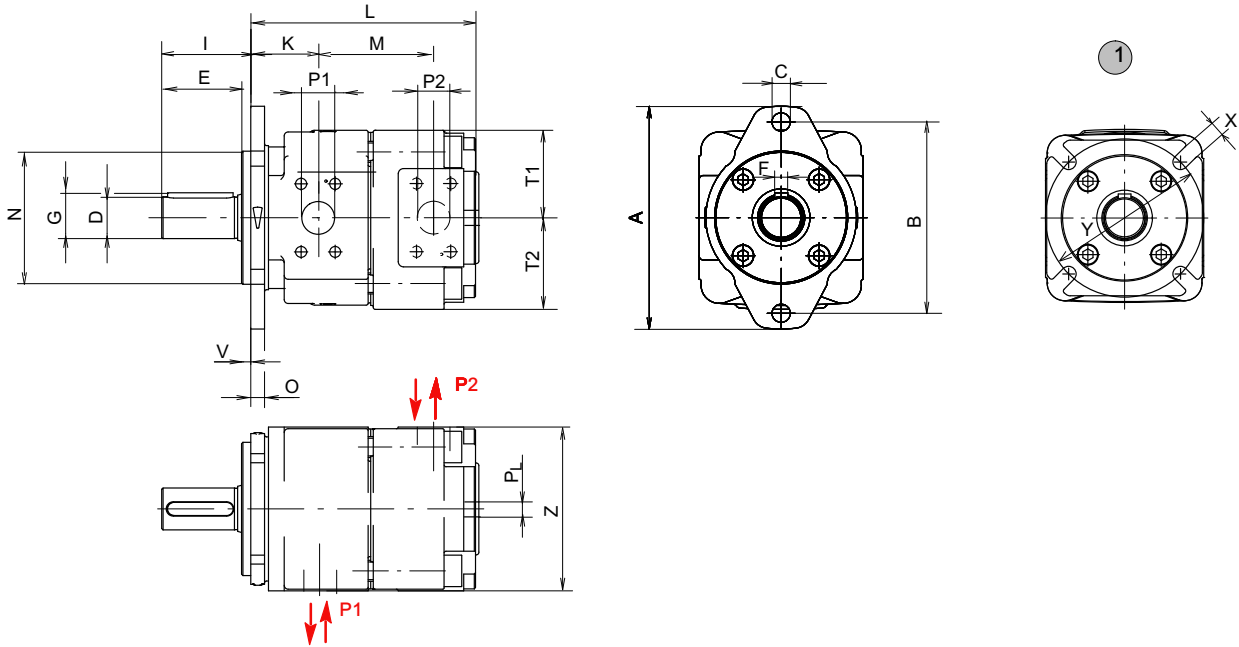

1 special model: 4-hole flange ISO 3019/2

### 4.3 Pressure range 3

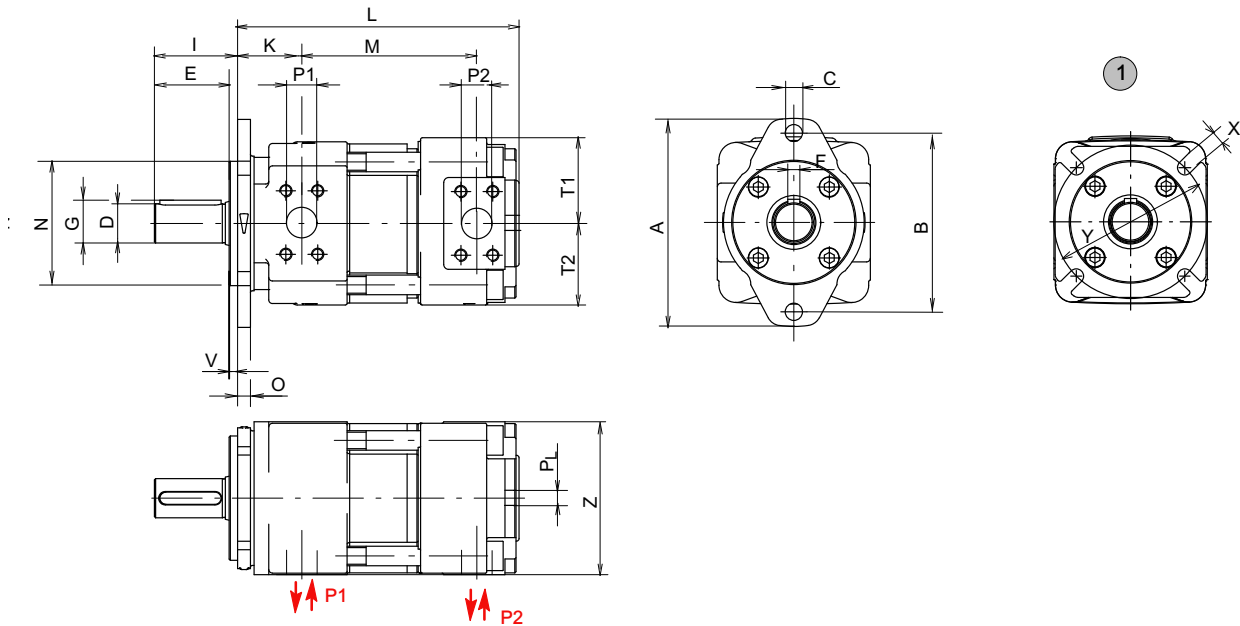

1 special model: 4-hole flange ISO 3019/2

### 4.4 Ordering details

		Q	X	M	5	3	-	0	4	0	N	*	*	*
Internal gear unit	= QXM													
Frame size	= 2 / 3 / 4 / 5 / 6 / 8													
Pressure range	= 1 / 2 / 3													
Geom. Displ./Consump. in cm <sup>3</sup> /rev	= 005 - 500													
Direction of rotation, unrestricted	= N (see section 4.8)													
Variants / special features	(to be inserted by the factory, see section 4.7 for a selection)													

### 4.5 Ordering example

Required: Internal gear unit QXM  
 Displ./Consump.: 40 cm<sup>3</sup>/rev  
 Continuous pressure: 300 bar  
 For use with mineral oil: HLP  
 Ordering code: QXM53-040 N

### 4.6 Standard configuration

- Direction of rotation - unrestricted
- 2-hole mounting flange to ISO 3019/1;  
Frame size QXM 3-6
- 2-hole mounting flange to ISO 3019/2;  
Frame size QXM 2+8
- Nitrile seals
- Cylindrical shaft end to ISO R775
- Separate drain port
- Ports P<sub>1</sub> + P<sub>2</sub> both the same size
- High pressure shaft seal
- Black priming, flange without priming

### 4.7 Special features

- O = without priming
- 09 = FPM(Viton)seals, without priming
- 130 = 2-quadrant operation, service port dimensions as per QX pumps  
2-hole mounting flange to ISO 3019/2 (metric)

For other special features contact Bucher Hydraulics.

### 4.8 Direction of rotation

Direction of rotation: right:  
(clockwise, viewed from the shaft end) = oil flows from P<sub>1</sub> to P<sub>2</sub>

Direction of rotation: left:  
(counterclockwise, viewed from the shaft end) = oil flows from P<sub>2</sub> to P<sub>1</sub>

## 5 Fluid cleanliness

QXM internal gear units require a fluid with a minimum cleanliness level of ISO 4406 code 20/18/15.

We recommend the use of fluids that contain anti-wear additives for mixed-friction operating conditions. Fluids without appropriate additives can reduce the service life of pumps and motors. The user is responsible for maintaining, and regularly checking, the fluid quality. Bucher Hydraulics recommends a load capacity of  $\geq 30 \text{ N/mm}^2$  to Brugger DIN 51347-2.

## 6 Note

This catalogue is intended for users with specialist knowledge. The user must check the suitability of the equipment described herein in order to ensure that all of the conditions necessary for the safety and proper functioning of the system are fulfilled. If you have any doubts or questions concerning the use of these pumps, please consult Bucher Hydraulics.

## 7 Fluid cleanliness

Cleanliness class (RK) as per ISO 4406

Code ISO 4406	Dirt particle number / 100 ml		
	$\geq 4 \mu\text{m}$	$\geq 6 \mu\text{m}$	$\geq 14 \mu\text{m}$
23/21/18	8000000	2000000	250000
22/20/18	4000000	1000000	250000
22/20/17	4000000	1000000	130000
22/20/16	4000000	1000000	64000
21/19/16	2000000	500000	64000
20/18/15	1000000	250000	32000
19/17/14	500000	130000	16000
18/16/13	250000	64000	8000
17/15/12	130000	32000	4000
16/14/12	64000	16000	4000
16/14/11	64000	16000	2000
15/13/10	32000	8000	1000
14/12/9	16000	4000	500
13/11/8	8000	2000	250

## 8 Operational reliability

To ensure a reliable operation and a long service life a maintenance schedule must be prepared for the power unit, machine or system. The maintenance schedule must make sure that the provided or permissible operating conditions are adhered to over the period of use.

In particular, compliance with the following operating parameters must be ensured:

- The required oil cleanliness
- The operating temperature range
- The fluid level

Moreover, the QXM internal gear units and the system must be inspected at regular intervals for changes in the following parameters:

- Vibration
- Noise
- Differential temperature – fluid in the tank
- Foaming in the tank
- Freedom from leakage

Changes in these parameters indicate wear of components (e.g. drive motor, coupling, internal gear unit, etc.). The cause must be immediately pinpointed and eliminated.

To provide high operational reliability in the machine or system, we recommend continuous, automatic checks of the above parameters and an automatic shutdown in the case of changes that exceed the usual fluctuations within the provided operating range.

Commissioning see operating instructions 100-B-000014

## 9 Accessories

### 9.1 Pipe flanges - high pressure type

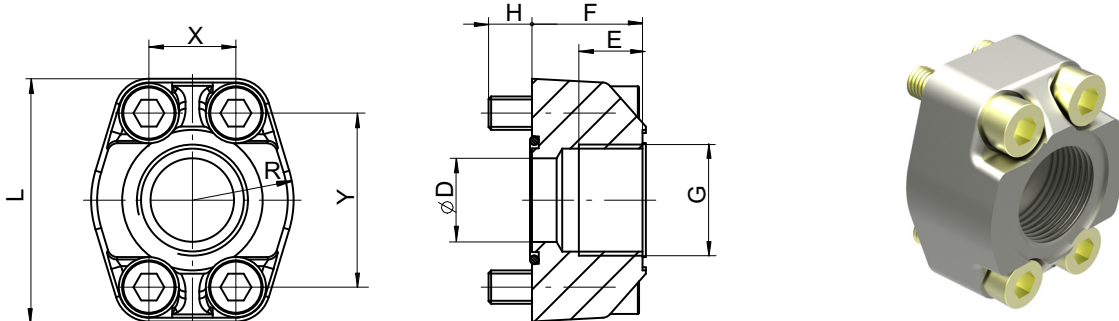

- Max. operating pressure 420 bar
- Flange size SAE J518 code 61 / ISO 6162-1
- Material: ST37

- FPM(Viton) seals on request
- Threaded pipe flanges are spot-faced for DIN 2353 pipe fittings.

Ordering-number	Ordering code	Size	D $\phi$	E	F	H	L	R	X	Y	Viton seal 90 Shore 'A'	Retaining screws DIN912-12.9 / Torque Nm
100037000	RF 01-R08	G 1/2"	12,5	16	27	13	54	23	17,5	38	20,24x2,62	M8x30 30
100037010	RF 02-R10	G 3/4"	20	18	30	12	65	26	22,2	47,6	26,65x2,62	M10x30 60
100037020	RF 03-R11	G 1"	25	20	34	13	70	29	26,2	52,4	32,99x2,62	M10x35 60
100037030	RF 04-R12	G 1 1/4"	32	22	38	14	80	36	30,2	58,6	40,86x3,53	M10x40 60
100037040	RF 05-R13	G 1 1/2"	38	24	41	19	94	41	35,7	70	44,04x3,53	M12x45 120
100037050	RF 06-R14	G 2"	50	26	45	20	102	48	42,9	77,8	59,92x3,53	M12x50 120
100055470*	RF 07-R16	G 2 1/2" *	63	30	50	18	114	57	50,8	89	72,62x3,53	M12x45 120

\* At RF07 only to 210 bar be allowed.

### 9.2 Low pressure type

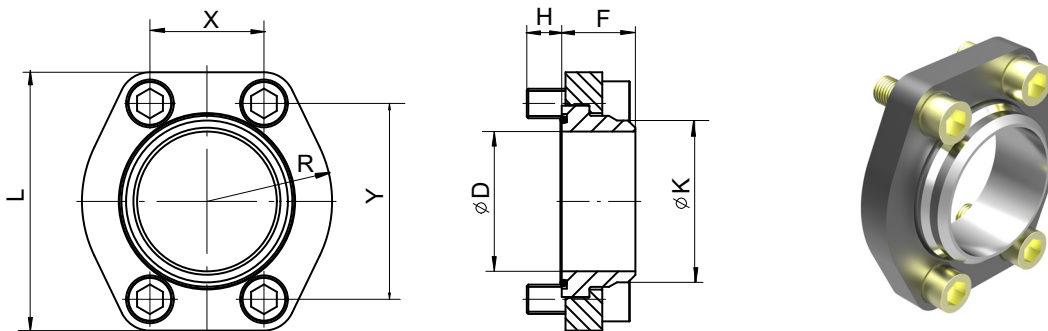



- Max. operating pressure 16 bar
- Flange size SAE J518 code 61 / ISO 6162-1

- Material: ST37
- FPM(Viton) seals on request

Ordering number	Ordering code	SAE flange Size	D	K	F	H	L	R	X	Y	Viton seal 90 Shore 'A'	Retaining screws DIN 912-8.8 Torque Nm	pipe <sup>1)</sup> $\phi$ dia. approx.
100062450	RN07-S	2 1/2"	63	75	35	14	120	57	51	89	69,44x3,53	M12x30 70	75
100063880	RN08-S	3"	76	88			140,5	68	62	106,5	85,32x3,53	M16x40 180	88
100063890	RN09-S	3 1/2"	89	100	40	19	158,5	73	70	120,3	98,02x3,53	M16x40 180	100
100063900	RN10-S	4"	103	115			168	79	78	130	110,72x3,53	M16x40 180	115

1) We recommend the use of seamless precision steel tube to DIN 2391 with-wallthick. max 6 mm.

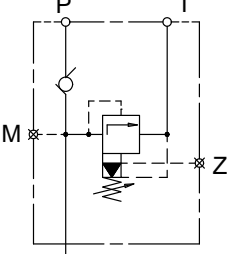
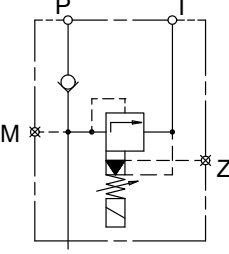
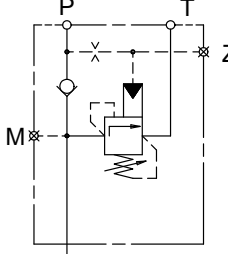
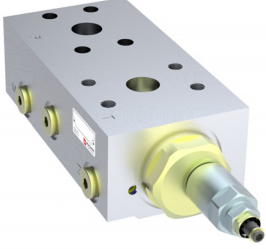
### 9.3 Bolt-on valves - SAE J518 code 61 / ISO 6162-1 pattern

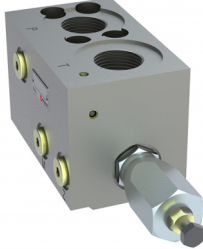
Pressure relief valve A <sub>G</sub> S <sub>G</sub> DF / ASDH	Pressure relief valve solenoid control A <sub>G</sub> S <sub>G</sub> DA	Accumulator charging valve AGSF
		
		
Technical data sheet 100-P-000123	Technical data sheet 100-P-000119	Technical data sheet 100-P-0000124

#### 9.3.1 Examples for Bolt-on valves, mounted on QX Internal Gear Motors

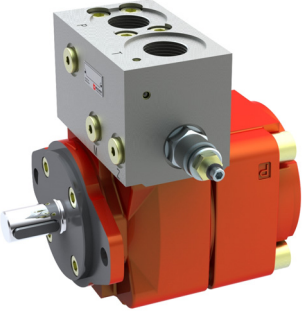
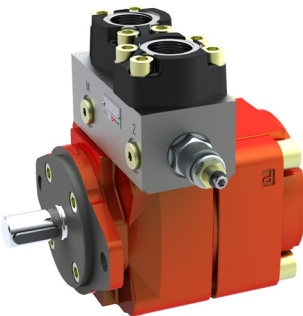
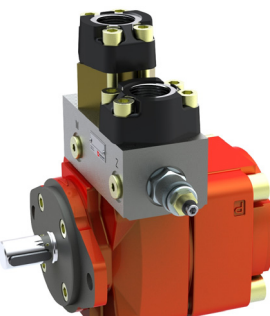
Bolt-on valve with threaded ports AGDF	Bolt-on valves with pipe flanges SAE <sup>1)</sup> ASDF+RF	Bolt-on valve with pipe flanges SAE + RVSAE <sup>2)</sup> ASDF+RF+RVSAE+DPSAE+ZPSAE
		

**IMPORTANT:** For detailed informations on Bolt-on valves see [www.bucherhydraulics.com](http://www.bucherhydraulics.com)

[info.kl@bucherhydraulics.com](mailto:info.kl@bucherhydraulics.com)

[www.bucherhydraulics.com](http://www.bucherhydraulics.com)

© 2017 by Bucher Hydraulics GmbH, D-79771 Klettgau

All rights reserved.

Data is provided for the purpose of product description only, and must not be construed as warranted characteristics in the legal sense. The information does not relieve users from the duty of conducting their own evaluations and tests. Because the products are subject to continual improvement, we reserve the right to amend the product specifications contained in this catalogue.

Classification: 420.245. 200